

**MEM Bocca di erogazione a getto per vasca senza deviatore per montaggio
bordo vasca - Platinato**

MEM

13 630 740



- sporgenza 235 mm
- Cascata
- altezza rubinetteria 100 mm
- altezza fino al rompigitto 80 mm
- diametro foro 32 mm
- ingresso 1/2"
- portata max 26,5 l/min a una pressione idraulica di 3 bar

	Platinato	13 630 740-08
	Cromato	13 630 740-00
	Platinato spazzolato	13 630 740-06
	Dark Chrome	13 630 740-19
	Ottone spazzolato (Oro 23k)	13 630 740-28
	Champagne spazzolato (Oro 22k)	13 630 740-46
	Champagne (Oro 22k)	13 630 740-47
	Dark Platinum spazzolato	13 630 740-99

13 630 740
mm [inches]



Diagramma di portata



Diagramma gittate

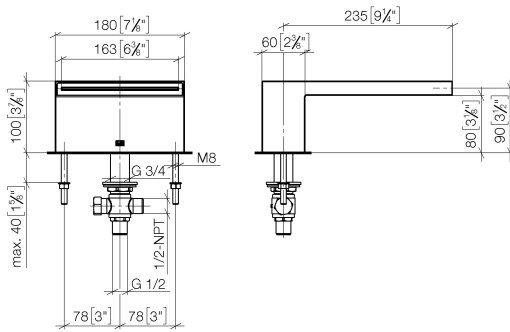
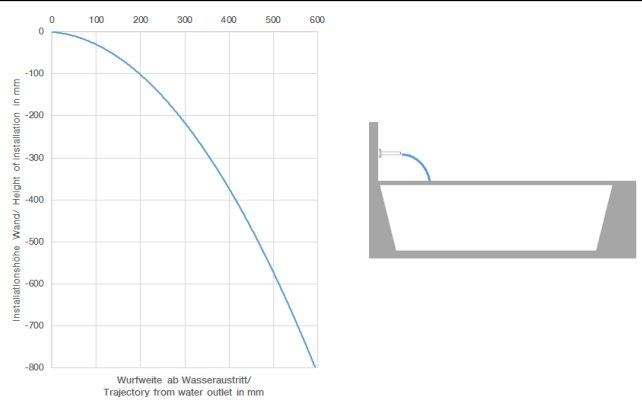

Certificati

IAPMO_4976 (2). LGA_19257. WRAS_1809016.

13 630 740
Parts for other
finishes can be found
here: Cromato

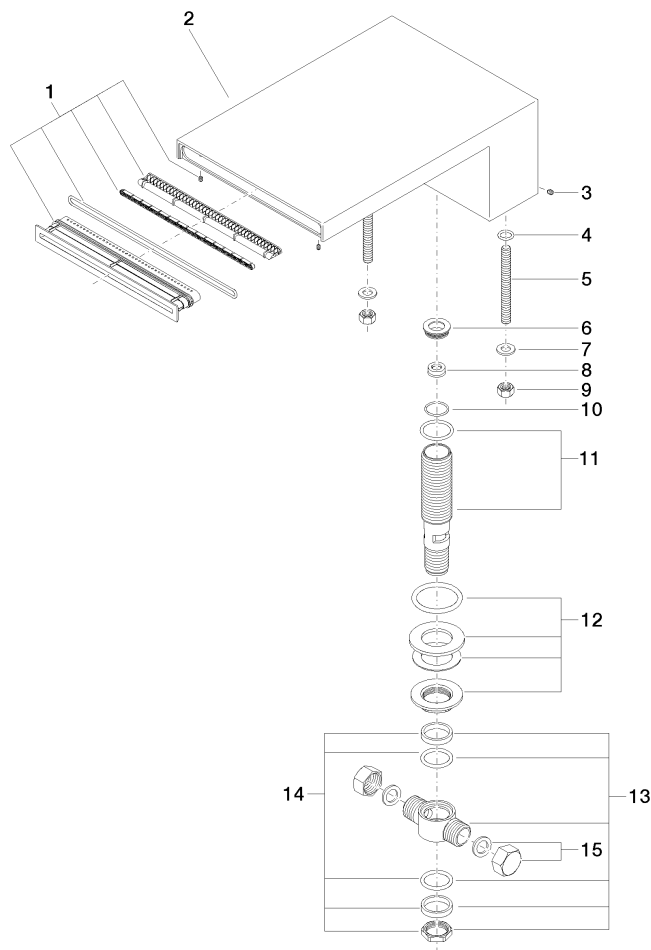

Elenco delle parti di ricambio

N.	Codice articolo	Denominazione	Quantità necessaria	Tempo di produzione
1	90 29 03 059 00 90	inserto	1	2
2	09 11 74 040-08	bocca di erogazione	1	40
3	09 31 11 044 90	perno	1	2
4	09 14 10 008 90	guarnizione	2	2
5	09 31 11 011 90	perno	2	2
6	09 24 04 246 20 90	ugello	1	2
7	09 30 11 045 90	rondella	2	2
8	09 23 01 057 90	limitatore di portata	1	2
9	09 23 10 023 90	dado	2	2
10	09 14 10 140 90	guarnizione	1	2
11	90 30 01 033 00 90	alloggio	1	2
12	04 23 10 004 04 90	set di fissaggio	1	2
13	90 17 11 020 10 90	distributore	1	2
14	90 23 10 012 00 90	corredo della guarnizione	1	2
15	04 21 02 006 00 92	calotta	2	2